



BPOWER XT 145 6V 260Ah

The XT series lead-acid batteries are specially designed for cyclic work. Design life for the 80% deep of discharge is 700 cycles. XT series works perfectly as an autonomous source power supply in scissor lifts and trolleys golf clubs or cleaning machines.

BASIC PARAMETERS		CYCLE LIFE	
Rated Voltage (V)	6	Cycle Life (Time)	700 cycles for 80% depth of discharge
Rated Capacity 20HR (Ah)	260	Design Life (Year)	5 years
Rated Capacity 5HR (Ah)	215		
OPERATION PARAMETERS		ENVIRONMENT PARAMETERS	
Recommend Charge Current (A)	26,00	Charge Temperature Range	5°C ~ 45°C
Max Constant Charge Current (A)	33,80	Discharge Temperature Range	- 10°C ~ 45°C
Charging Vol. During Cyclic Work (V)	7,50	Storage Temperature Range	5°C ~ 40°C
		Self Discharge at 20°C	Up to 15% for a month depending on the storage temperature
PHYSICAL PARAMETERS		CHARGING STATUS	
Dimensions (L x W x H)	260 x 180 x 279 mm	100%	2,22V / cell
Weight (kg)	30,4	75%	2,12V / cell
Terminals	Dual Terminal ET	50%	2,07V / cell
Case Material	Polypropylene PP	25%	2,02V / cell



Cycle life

Long cycle service life, strong recovery ability of deep discharge.



Tight construction

Reliable sealing structure ensures no leakage during use.



Efficiency

Special plate design and grid structure increase battery performance.



Maintenance

Good heat dissipation conditions, low risk of thermal runaway, easy maintenance.



High performance

High energy, low internal resistance, low self-discharge, no noise, easy to operate.



Corrosion resistance

The special alloy improves the corrosion resistance of the plate, increases the service life of the battery and good deep discharge performance.

Headquarters in Warsaw
Jana Kazimierza 61
01-267 Warszawa

Branch in Gdansk
Twarda 12
80-871 Gdańsk

+48 22 877 54 96
biuro@baterie.com.pl
www.baterie.com.pl

**BP BATERIE
PRZEMYSŁOWE**

Terminals

Positive 19.5
Negative 17.9

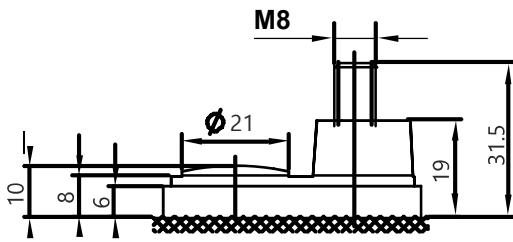

Torque value: 110-120 [Nm]

Cycle life

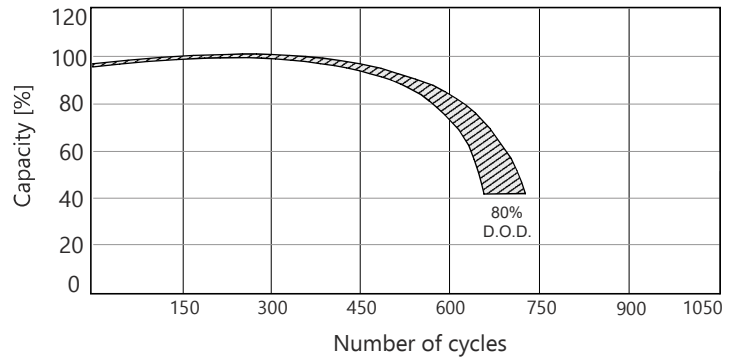

Dimensions

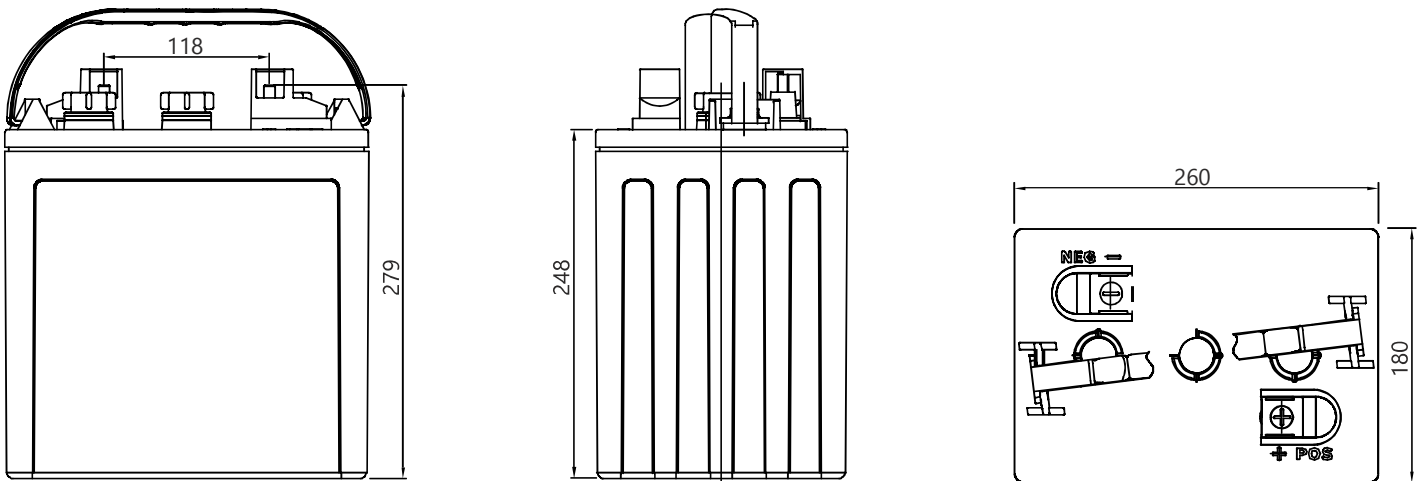

Environment information

Exploited batteries are considered as hazardous waste. These wastes due to their origin, chemical composition (they contains heavy metals like lead and other toxic substations) and other features may be dangerous for environment and human or animal health life. According to the waste act, waste in the form of batteries and accumulators should be collected separately from other types of waste.

In order to obtain more detailed information, we encourage you to contact us, we provide any information on how to handle with waste batteries and accumulators..

Safety



Recycling



Headquarters in Warsaw
Jana Kazimierza 61
01-267 Warszawa

Branch in Gdansk
Twarda 12
80-871 Gdańsk

+48 22 877 54 96
biuro@baterie.com.pl
www.baterie.com.pl

BP BATERIE
PRZEMYSŁOWE